

ODESSA

Black Series



ComfortBase®

Owner's Manual



Contents

Safety Information	2
What Is Included	5
Assembly - Base	6
Assembly - Headboard Bracket	9
Location of Controls - Remote	11
Operation - Main	12
Troubleshooting	12
Available Accessories	15
Specifications	16
Technical Assistance	16
Service Requirements	16
Cleaning	16
Warranty	17

User Info

Please take a moment and write down the serial number in the space provided below, in case you need to refer to it in the future. This information can be found by raising the head section of the bed.

SKU: CB18X40R12

Serial Number _____

This number will be required for future service claims.

SAFETY INFORMATION

ATTENTION!

**IMPORTANT SAFETY INSTRUCTIONS. SAVE THIS MANUAL!
PLEASE READ THESE INSTRUCTIONS THOROUGHLY BEFORE USING
THIS PRODUCT. PROPER OPERATION OF YOUR ADJUSTABLE BED IS
NECESSARY TO ENSURE THE LONG LIFE AND DURABILITY YOU
EXPECT FROM A HIGH-QUALITY PRODUCT. THE MANUFACTURER
HAS TESTED AND INSPECTED THIS PRODUCT PRIOR TO SHIPMENT.**

RADIO FREQUENCY IS 2.4 GHZ.

FCC compliance device complies with part 15 of the FCC Rules.

Operation is subject to the following two conditions:

- (1) This device may not cause harmful interference, and
- (2) this device must accept any interference received, including interference that may cause undesired operation.

Any change to the antenna or the device could result in the device exceeding the RF exposure requirements and void the user's right to operate the device.

The input voltage is AC100-240 50/60HZ; the output voltage is DC29V 1.8A.

ELECTRICAL SAFETY

Always unplug this adjustable bed frame from the electrical outlet before any cleaning or maintenance of the bed frame. To safely disconnect, remove the plug from the outlet. Keep cord away from heated surfaces. Use only indoors.

WARNING: TO PREVENT FIRE OR SHOCK HAZARD, DO NOT EXPOSE THIS UNIT TO MOISTURE.

Discontinue use of this adjustable bed base and contact the manufacturer for repair if:

- (1) it has a damaged cord or plug, (2) it is not working properly, (3) it has been dropped or damaged.

FOR OPTIMAL SAFETY, YOUR ADJUSTABLE BED SHOULD BE PLUGGED INTO A SURGE PROTECTOR (not supplied with this adjustable bed).

BATTERY PRECAUTIONS

Follow these precautions when using batteries in this device:

1. Warning – Danger of explosion if battery is incorrectly replaced. Replace only with the 6LR61 9V batteries and LRO3 AAA batteries.
2. Be sure to follow the correct polarity when installing the batteries as indicated in the battery compartment. A reversed battery may cause damage to the device.
3. Do not mix different types of batteries together (e.g. Alkaline, Rechargeable and Carbon-zinc) or old batteries with fresh ones.
4. If the device is not to be used for a long period of time, remove the batteries to prevent damage or injury from possible battery leakage.
5. Do not try to recharge a battery not intended to be recharged; it can overheat and rupture. (Follow battery manufacturer's directions.)

SAFETY INFORMATION

WARRANTY WARNING!

This bed is specifically designed to require no maintenance by you, the user. Any opening or tampering with the control box, motors or hand controls (with the exception of the battery compartment, if equipped) will void the warranty. Do not attempt to alter component wiring or adjust or modify the structure of the product in any way or the warranty will be void. Only those authorized may conduct repairs or part replacement on your adjustable bed.

IN-HOME USE ONLY

This adjustable bed is designed exclusively for in-home use.

HOSPITAL/MEDICAL DISCLAIMER: This base is NOT designed for hospital or medical use (In-Home or Commercial) and is NOT designed to meet medical or hospital standards. Do not use this base with TENT TYPE oxygen therapy equipment or use near explosive gases.

CONSUMERS WITH PACEMAKERS

It is possible that the vibrating feature of this bed may be interpreted falsely by some pacemakers as movement and/or exercise. This is common with any product that produces a vibrating motion, and may or may not affect your pacemaker. Please consult your physician with any concerns.

PRODUCT RATINGS

Lift Motor Restrictions: The lift motors in this bed are NOT designed to operate continuously for more than one (1) minute over an eight (8) minute time period, or approximately 12% duty cycle. To ensure reliable functionality and full life of this product, do not attempt to exceed these limits.

NOTE: Attempting to circumvent or exceed this rating will shorten the life expectancy of the product and may void the warranty.

Weight Restrictions: The recommended weight limits on our adjustable beds are:
Queen: 650 lb Twin/XL: 400 lb (800 lb if using two twins as a King)

The structure of the bed will support the recommended weight when distributed evenly across the bed.

The head and foot sections are not designed to individually support or lift this amount of weight.

For optimal performance and integrity of structure, entering and exiting the adjustable bed with the bed in the flat position is recommended.

NOTE: Exceeding the recommended weight restrictions could damage your adjustable bed and void your warranty.

Vibe Motor Restrictions:

Vibe motors are not designed for continuous, extended vibe motor operation. Vibe motor systems are rated for a maximum of two hours of use within any six hour period.

The vibe motor feature will emit a minimal tone during operation. This is normal. When the vibe motor level is increased, motor resonance will intensify accordingly.

SAFETY INFORMATION

SMALL CHILDREN AND PETS WARNING

Immediately dispose of all packing materials as they can pose a smothering risk to small children and pets. Injury could occur also if children or pets are permitted to play on or under the bed. Do not allow children to operate this bed without adult supervision.

LUBRICATION AND CLEANING

This product is designed to be maintenance free. The lift motors are permanently lubricated and sealed—no additional lubrication is required. Do not apply lubricant to lift motor lead screws or any nylon nuts or the base may inadvertently creep downward from the elevated position.

LIFT WARNING

DO NOT SIT ON THE HEAD OR FOOT SECTIONS WHILE IN THE RAISED POSITION, OR DURING LIFT OR LOWERING CYCLES.

LOCATION ENVIRONMENT

The level of sound experienced during operation is directly related to the location environment. For example, when a base is located on a hardwood floor with the vibrate feature in operation, a vibrating tone will be audible. To minimize this resonance, place a piece of carpet under each leg of the base.

It is possible to experience vibration or noise from the headboard brackets, headboards or foot boards if mounting bolts are not firmly tightened.

MOVING AFTER INSTALLATION

Do not place adjustable bed base vertically on its head or foot sections. This may cause injury to persons or damage to base.









WARNING!

To reduce the risk of burns, fire, electric shock, or injury to persons:

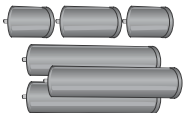
- Unplug from outlet before putting on or taking off accessories.
- Close supervision is necessary when this base is used by, or near children, invalids, disabled persons, or pets.
- Use this base only for its intended use as described in these instructions. Do not use attachments not recommended by the manufacturer.
- Never operate this base if it has a damaged cord or plug, is not working properly, has been dropped or damaged, or dropped in water.
- Keep the cord away from heated surfaces.
- Never drop or insert any object into any opening.
- Do not use outdoors.
- Do not operate where aerosol (spray) products are being used or where oxygen is being administered.
- To disconnect, remove plug from outlet.
- **DO NOT USE NEAR PEOPLE USING OR WEARING MEDICAL DEVICES. FOR HOUSEHOLD/RESIDENTIAL USE ONLY.**

WHAT IS INCLUDED

Before discarding any packing materials, check the adjustable base shipping carton and verify the following items are included:

	(1) Base
	(1) Foot Mattress Retainer (attached to the base)
	(4) Multi-Height Low Profile Legs (Overall Bed height 8", 11.5" or 15")
	(1) AC Cord (not attached to the base)
	(1) Power Supply (not attached to the base)
	(1) DC Power Cord
	(1) Headboard Bracket Kit
	(1) Sync Cable (Twin XLs only)
	Also included: (2) 9V Batteries

ASSEMBLY - BASE

It is HIGHLY recommended to use two people for the installation of this product. To assemble, please perform the following steps:

- 1 Carefully lift the base frame from the shipping carton, keeping the unit top-side-down. Remove the plastic wrapping from the bottom to access the base.

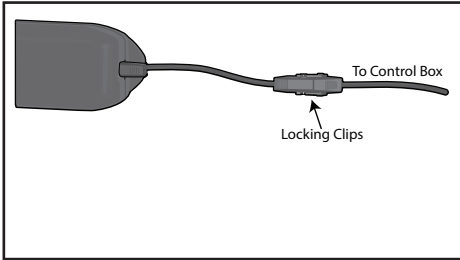

- 2 Insert one end of the DC cord into the power supply. Insert the other ends with locking clips into the Control Box and USB Charger cords. Lock the Control Box and USB Charger cords using the locking clips.

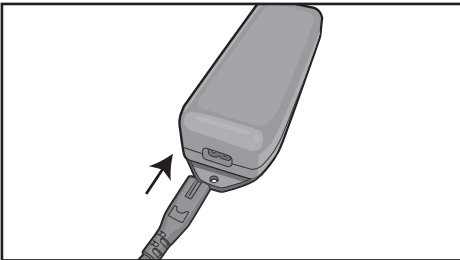

- 3 Insert the AC cord into the power supply.
IMPORTANT: DO NOT PLUG THE BASE INTO THE AC OUTLET YET.

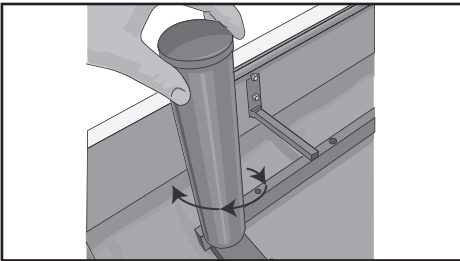

- 4 Insert the legs into the threaded holes at each corner of the base by inserting the leg and rotating clockwise until tight. There must not be any gap or wobble in the leg in order to avoid risk of injury or damage to the base which may void warranty.

NOTE: If setting up two Twin XL's bases, follow the instructions on page 08.

- 5 Remove the Mattress Retainer Bar from the bottom of the base. Finish removing the plastic packaging from the base to orient into final position. Carefully rotate the base on its side, then lift and place on legs.

IMPORTANT: DO NOT LEAN THE BED AGAINST THE INSTALLED LEGS TO TURN OVER.

Note: If attaching a headboard to the base, see the included instructions. Otherwise, place the desired mattress onto the base and enjoy your new adjustable base!

ASSEMBLY - BASE

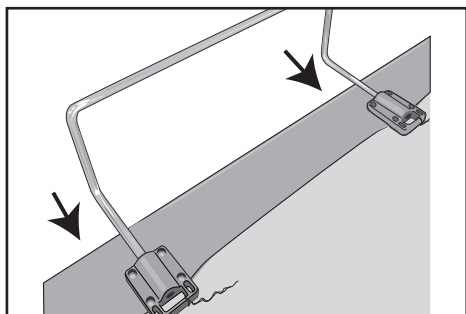

6 Insert the Mattress Retainer Bar upright as shown.

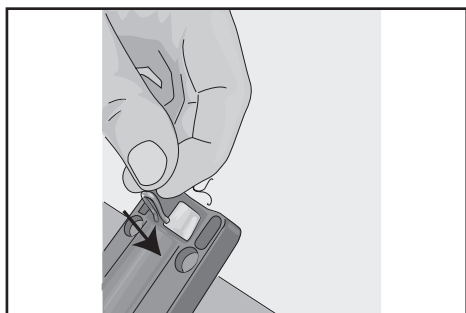

7 Replace the retainer clip securely.

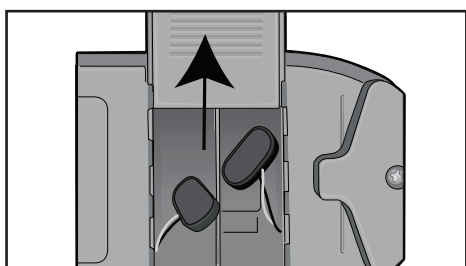

9 Turn the power supply upside down to access the battery cover, then slide the battery cover off.

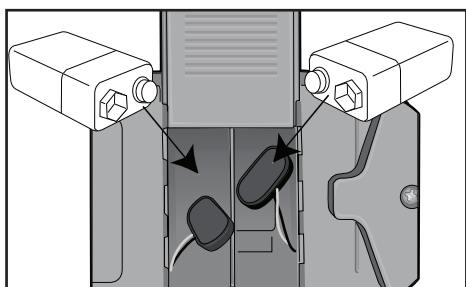

10 Insert the two 9V battery (included) into the compartment and slide the cover back on.

NOTE: The battery backup will allow for the bed to be lowered if a power outage occurs. It is not recommended to do anything except lower the bed as the battery backup will not last if the features are continually used.

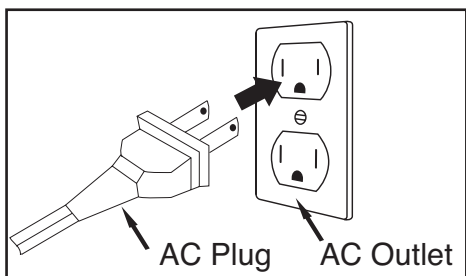

11 Insert AC plug into an AC outlet having 100-240V AC, 50/60Hz.

Bluetooth & Wi-Fi



Download our apps in the Apple or Google Play store. Open the app & follow the instructions. You will then be able to control your Base from any Apple or Android device!

ASSEMBLY - 2 TXL BASES

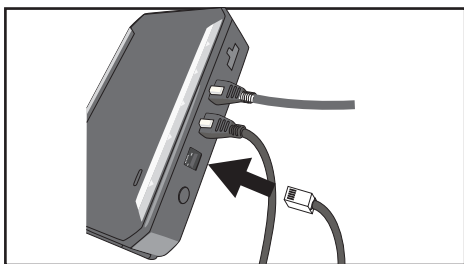

1 If setting two Twin XL's bases to use with one king size mattress, connect the Sync cable to the control box (as pictured) to one base. After bases are arranged, connect the second Sync Cable to other base's control box.

NOTE: FOR TXL AND SCK BASES ONLY - If you have two bases connected with a sync cable: Disconnect the Wi-Fi and/or Bluetooth module from one of the two control boxes before you begin use.

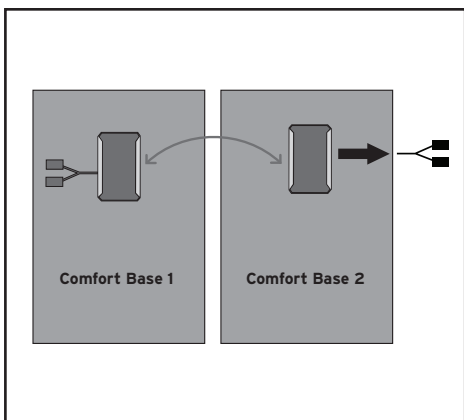

NOTE: If you have two bases connected with a sync cable: Disconnect the Wi-Fi and/or Bluetooth module from one of the two control boxes before you begin use.

ASSEMBLY - HEADBOARD BRACKET

IMPORTANT: The headboard bracket must be assembled to the base AFTER the bed base has been completely assembled. After assembling the bed according to the owner's manual, see this sheet to assemble the headboard bracket.

Unpack the kit and make sure the following is included:

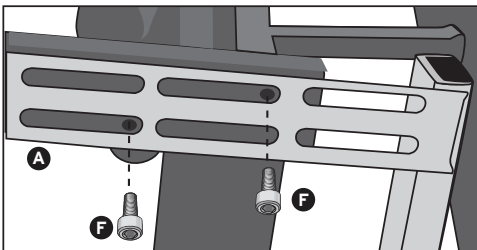
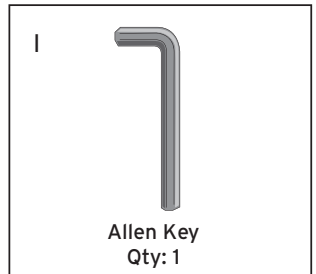
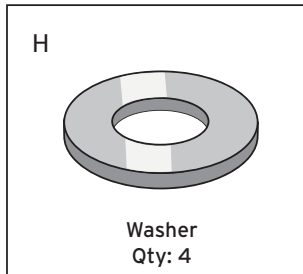
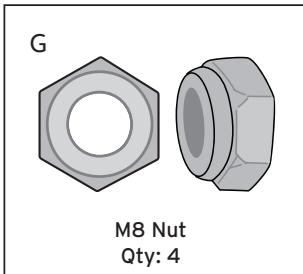
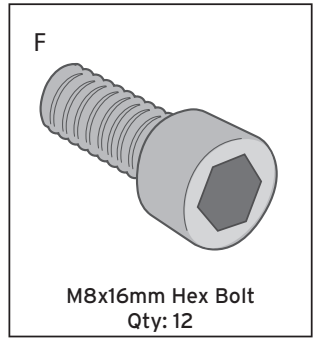
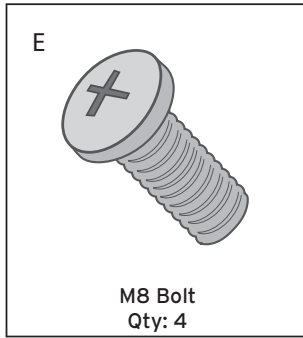
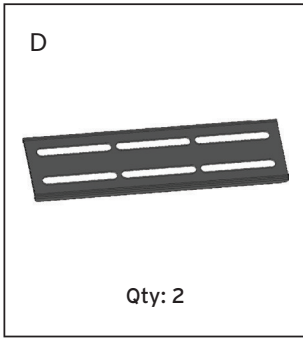
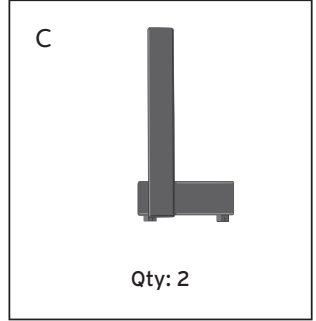
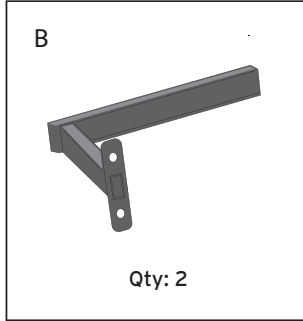
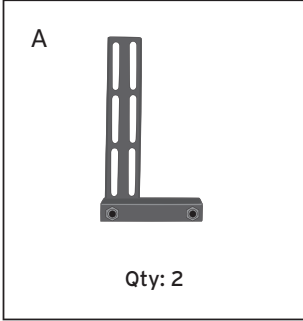

- 1 Remove the Mattress Retainer Bar from Align bracket A with holes running alongside base. Secure with 2 hex bolts F threading through headboard bracket mounting.

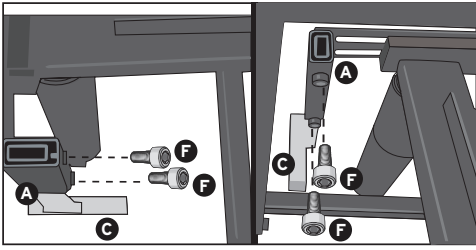

2 Insert part C in to part A and secure with 2 hex bolts F.

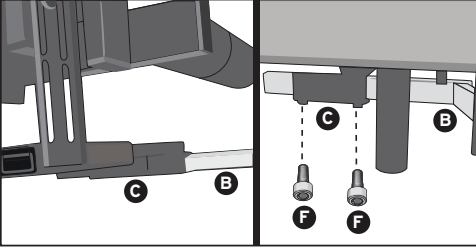

3 Insert part B into part C and secure with 2 hex bolts F.

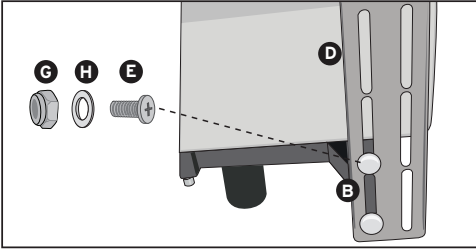

4 Put E through Part B and Part D. Then use H and G to fasten.

ASSEMBLY WITH ELEVATION KIT

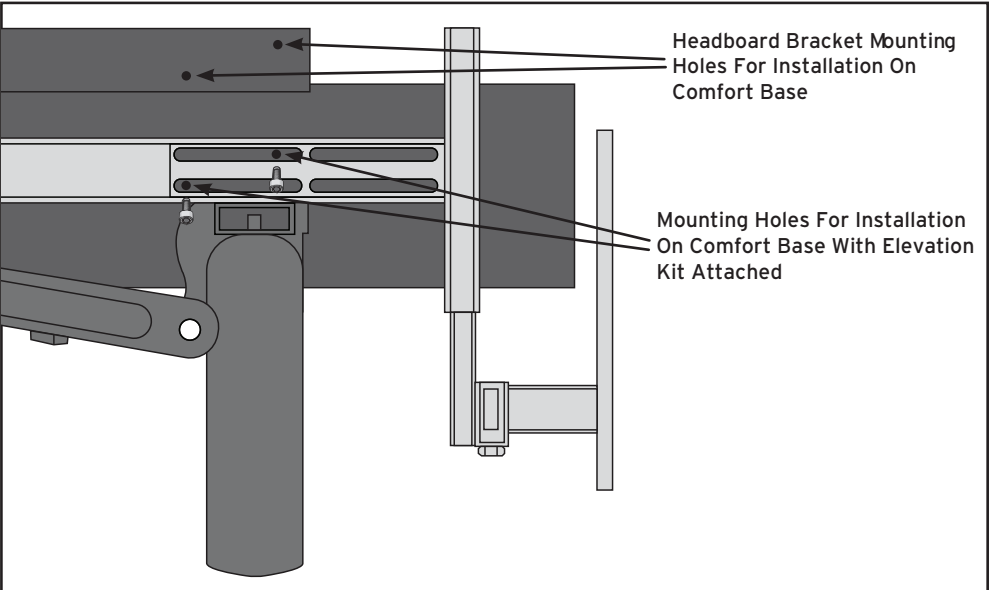

1 If attaching headboard brackets to a base with the elevate feature, please be sure to attach the brackets along the elevate kit. See image (location) to help locate the correct mounting location.

LOCATION OF CONTROLS - REMOTE

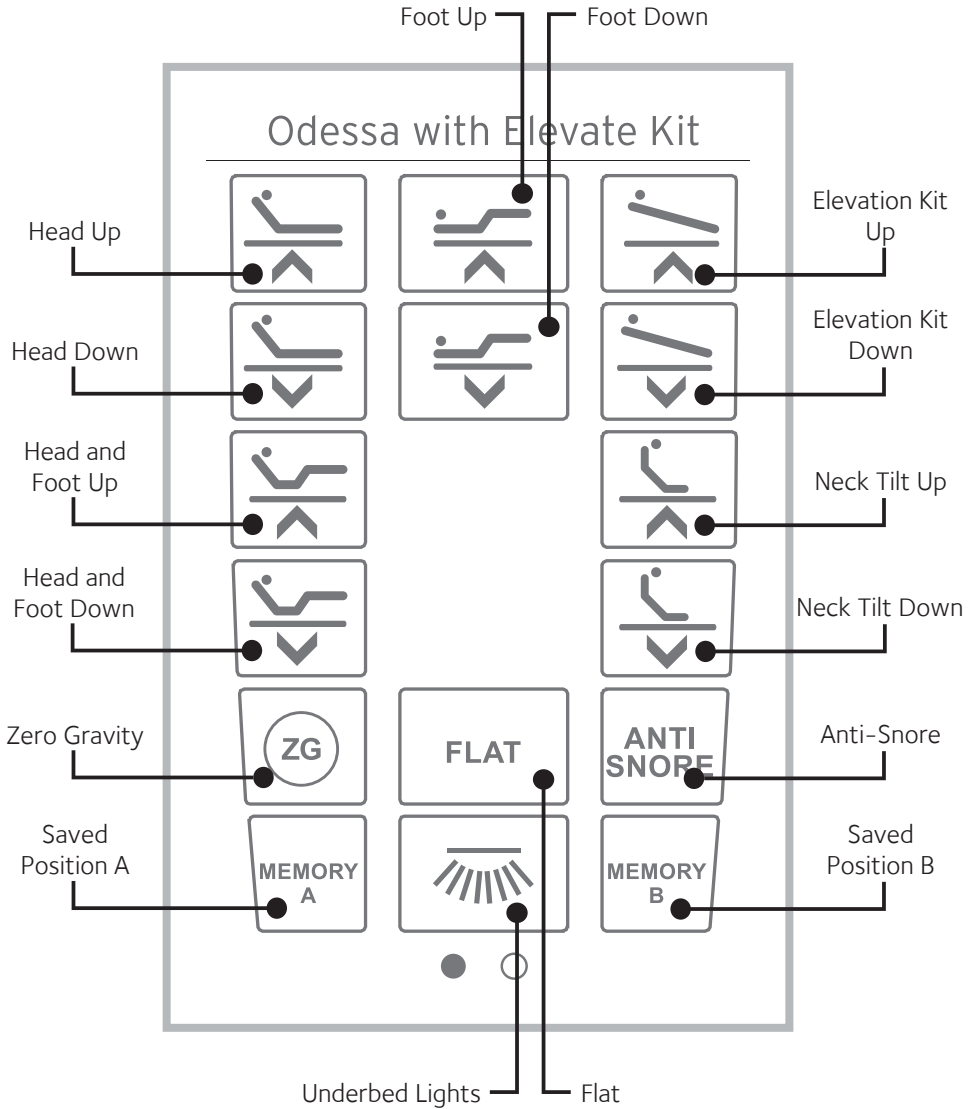

Get The App



Download our apps in the Apple or Google Play store. Open the app & follow the instructions. You will then be able to control your Base from any Apple or Android device!

OPERATION - MAIN

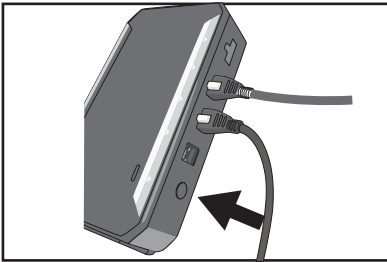
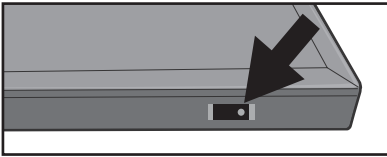
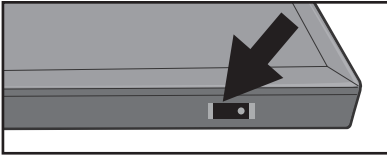

USB: This bed can charge standard devices that utilize a USB cable. A pair of USB jacks are located on each side of the bed base. Simply plug a USB cable into one of the USB jacks, and the other end into the device you want to charge.

Notes:

- When a unit connected to the USB jack is fully charged, remove the plug from the USB jack.
- **EMERGENCY LOWERING:** Locate and press the black Emergency Lowering button located on the main control box on the bottom of the bed (shown to the left).

TROUBLESHOOTING

How do I link my remote control to the Comfort Base?



- 1 Press and hold the Sync button on the side of your base until the under bed light starts to blink indicating the bed is ready to be synced to the remote. Release the button.
- 2 Simultaneously press and hold the Head Up and Foot Up buttons on the remote control. When the under bed light stops blinking, release the buttons.
- 3 Test the bed and repeat the steps if it is not working.

How do I Re-Program the Zero-Gravity button back to factory setting?

The Zero-Gravity button has the capability to be re-programmed. In case you would like to set it back to the original Zero-Gravity setting follow the below instructions:

1. Raise Head to 17 degrees.
2. Raise Foot to 25 degrees.
3. Press and hold the program button labeled "TIMER/ALL OFF button" until the remote starts to flash.
4. Release program button.
5. Press Zero Gravity button once.

TROUBLESHOOTING

In the event the Comfort Base's base fails to operate, investigate the symptoms and possible solutions provided below:



<p>Remote control illuminates and appears to be operable, but no features of the base will activate.</p>	<ul style="list-style-type: none"> • Unplug power cord, wait 30 seconds and plug in to reset electronic components. • Defective surge protection device or electrical outlet. Test outlet by plugging in another working appliance. • Electrical circuit breaker may be tripped. Check electrical service breaker box to verify. • Re-link the remote control (see Remote Control Re-Linking section of this manual for programming procedures).
<p>Remote control will not illuminate.</p>	<ul style="list-style-type: none"> • Replace batteries in the remote control.
<p>Head or foot section will elevate, but will not return to the horizontal (flat) position.</p>	<ul style="list-style-type: none"> • Base mechanism may be obstructed. Elevate base and check for obstruction. Remove obstruction. • Headboard may be too close to the edge of the mattress. Verify that distance between headboard brackets and mattress is sufficient. Adjust if required.
<p>Excessive massage motor noise.</p>	<ul style="list-style-type: none"> • If base is located on hard surface flooring, place carpet pieces or rubber cups under each leg of the base. • Verify that the base is not positioned against a wall, nightstand, or other object that may cause vibration or noise. • If base is installed inside a wood bed frame, verify vibrate motor is not causing bed frame (or bed frame components) to vibrate. • Verify that headboard attachment hardware is tightened firmly (if used).
<p>Head or Foot Lift Function has minor interference during operation.</p>	<ul style="list-style-type: none"> • Check batteries in remote, replace if necessary. • Make sure that you are following the duty cycle of the motor (do not operate more than one (1) minute over an eight (8) minute period, or approximately a 12% duty cycle). • Press the lift buttons squarely and accurately. • Control box may be experiencing common Radio Frequency Interference from other radio transmitting devices (see Remote Control Re-Linking section).

Continued on the Next Page

TROUBLESHOOTING

If USB ports do not charge:	Check the blue LED on the USB charging port, If it is on: <ul style="list-style-type: none">• Try another USB cable that is known good.• If USB port still does not charge, unplug all USB cables from base and allow USB charging port to reset. Wait 10 minutes and try again.• If it still does not charge, call for service.
If blue LED is off:	<ul style="list-style-type: none">• Check if base functions properly, if yes, then call for service.• If base does not work, check AC wall outlet power by plugging a known working appliance into it.• If outlet has power, call for service.
The remote is causing interference with appliances, TV, garage door opener, another base in a different room, etc.	<ul style="list-style-type: none">• Lift the battery cover on remote and remove the yellow sticker to expose the DIP switches. Slide the switches to different positions.• See page 16 for remote re-linking instructions.• After re-linking, test the bed to make sure it is working, and repeat steps if it is not.

AVAILABLE ACCESSORIES

	Item	Part Number
	High Profile Legs (Overall Bed Height 18.5")	CB3LEG18.5
	Remote Control	OK.312401
	Elevation Kit	CB18XKIT

To order an accessory, please call 1-800-428-5222

SPECIFICATIONS

Weight Capacity	Queen: 650 lb, Twin/XL: 400 lb (800 lb if using two twins as a King)
Power Input	AC100-240 50/60HZ
Power Transformer Output.....	DC29V 1.8A
Radio Frequency	2.4 GHZ
USB Power Output.....	2.1A (Max)
Overall Height of Bed.....	15 inches
Incline.....	Head - 65°, Feet - 35°
Included Accessories	Sync Cable (Twin XL size only), Mattress Retainer Bar, Headboard Bracket Kit, Power Supply, AC and DC Power Cords, (2) 9V Battery for Battery Backup,

TECHNICAL ASSISTANCE

For any questions, claims, or technical assistance, please contact Glideaway at 1-855-581-3095 or comfortbase@glideaway.com

SERVICE REQUIREMENTS

Service technicians are not responsible for moving furniture, removing headboards and foot boards, or any items required to perform maintenance on your adjustable bed. In the event the technician is unable to perform service due to lack of accessibility, the service call could be billed to the purchaser and the service will be re-scheduled.

CLEANING

Spot clean with upholstery shampoo, foam from a mild detergent, or mild dry cleaning solvent. Pre-test a small inconspicuous area before proceeding. Do not saturate. Pile fabrics may require brushing with a non-metallic bristle brush. Hot water extraction or steam cleaning is not a recommended cleaning method.

WARRANTY

Glideaway Premium Comfort Base® Fifteen Year Limited Warranty 1832.A

Glideaway Sleep Products ("Glideaway") warrants to the original consumer purchaser that the motorized bed frame, motorized bed foundation and adjustable bed (hereinafter referred to as "adjustable bed" or "adjustable beds") are free from defects in workmanship and material as provided herein. To the extent permitted by law, this Limited Warranty is not transferable and coverage terminates if the original consumer purchaser ("purchaser") sells or otherwise transfers the product. If you wish to make a claim you must contact the Glideaway dealer from whom the product was purchased, or if not available, Glideaway 1 855 581-3095 within thirty days of discovery of the problem with the serial number and the original sale receipt which identifies the date of purchase. Any information or materials to be returned upon authorization should be sent to Glideaway at 8226 Lackland Road, St. Louis, MO 63114.

What we will do

Years 1 through 3: Full coverage parts and labor warranty This adjustable bed is warranted against defects in the workmanship or materials for a period of up to three (3) years from the date of purchase for adjustable beds bought new and for up to three (3) years from the date of manufacture for those beds that were originally floor samples. Glideaway will send replacement parts (at no cost to the purchaser) for any defective adjustable bed part to the purchaser, and Glideaway will pay all pre-authorized labor and transportation costs associated with the repair or replacement of any parts which Glideaway determines to be defective. This three (3) year warranty shall not apply if purchaser does not return any and all defective parts to Glideaway within 15 days of purchaser's receiving of replacement part(s).

Years 4 and 5: Full coverage of parts only warranty If the defect occurs in the fourth or fifth year following purchase for adjustable beds bought new and following the date of manufacture for adjustable beds that were originally floor samples, Glideaway will offer replacement parts (upon terms and conditions set forth in this paragraph) for any mechanical adjustable bed part found to be defective or malfunctioning. This limited warranty shall not apply if purchaser does not return any and all defective or malfunctioning parts to Glideaway within 15 days of purchaser's receipt of replacement parts. To the extent permitted by law, the purchaser shall bear all service, transportation, labor, shipping and handling costs related to the delivery and/or replacement of the defective or malfunctioning parts.

Years 6 through 15: Prorated coverage of non-electrical parts only warranty If the defect occurs in the sixth through fifteenth year following purchase for adjustable beds bought new and following the date of manufacture for adjustable beds that were originally floor samples, Glideaway will offer replacement parts (upon terms and conditions set forth below) for any non-electrical part found to be defective or malfunctioning. Electronics, electrical components, massage motors and lift motors are excluded. Purchaser shall pay 1/15th of the then current replacement cost of the defective part multiplied by the number of years the purchaser has owned the adjustable bed for those beds bought new or multiplied by the number of years since the adjustable bed was manufactured for those adjustable beds which were floor samples. Glideaway shall bear the remainder of the cost of the replacement part. This limited warranty shall not apply if purchaser does not return any and all defective parts to Glideaway within 15 days of purchaser's receipt of replacement parts. To the extent permitted by law, the purchaser shall bear all service, transportation, labor, shipping and handling costs related to the delivery and/or replacement of the defective or malfunctioning parts.

This limited warranty does not cover or apply to

This Limited Warranty does not apply: (a) to any damage caused to the adjustable bed by the purchaser; (b) if there has been any unauthorized repair or replacement of the adjustable bed or parts; (c) if the adjustable bed has been mishandled whether in transit or by other means, subjected to physical or electrical abuse or misuse, or otherwise operated in any way inconsistent with the operation and maintenance procedures outlined in the Owner's Manual, this limited warranty, and any other applicable document published or approved by Glideaway; (d) in relation to damage to mattresses, fabric, cables, electrical cords or items supplied by dealers (also known as retailers or resellers); (e) if there has been any unnecessary service calls, including costs for in-home service calls solely for the purpose of educating the purchaser about the adjustable bed and/or for finding an unsatisfactory power connection; (f) if the recommended weight restrictions (Twin/TXL/Split Queen/Split CA King: 400 pounds/ 181 kilograms, Full/FXL: 500 Pounds/ 227 kilograms, Queen: 650 Pounds/ 295 kilograms, King 800 Pounds/ 363 kilograms) and guidelines for proper distribution of weight as stated in the Owner's Manual are not followed; (g) for adjustable beds used in commercial type settings, such as but not limited to dormitories, hotels and rentals.

Additional terms and conditions

No reimbursement will be made to the purchaser for the inconvenience, removal, installation, setup time, lack of use, shipping, or any other costs or expenses not covered by this limited warranty. Glideaway holds no responsibility for in-home service on adjustable beds. Purchaser should contact their dealer for any terms and conditions relating to purchaser's in-home service if any.

Removal of product tag shall void warranty. The product tag has both the model and serial numbers, which serves as a means of identification to establish one's warranty rights. It is attached to the metal substructure visible when one lifts the head of the base.

TO THE EXTENT PERMITTED BY APPLICABLE LAW, THIS LIMITED WARRANTY REPLACES ALL OTHER REPRESENTATIONS, WARRANTIES OR CONDITIONS, WHETHER EXPRESSED, IMPLIED OR LEGAL ARISING FROM STATUTE, COURSE OF DEALING, USAGE OF TRADE OR OTHERWISE INCLUDING ANY IMPLIED WARRANTIES OR CONDITIONS OF MERCHANTABILITY, DURABILITY, QUALITY AND FITNESS FOR A PARTICULAR PURPOSE AND NO ONE IS AUTHORIZED TO ASSUME OR UNDERTAKE FOR GLIDEAWAY OTHER LIABILITY IN CONNECTION WITH THE SALE OF THE PRODUCT. GLIDEAWAY SHALL NOT BE LIABLE FOR ANY DAMAGES, WHETHER DIRECT, INDIRECT OR CONSEQUENTIAL OR ANY OTHER DAMAGES OF WHATEVER KIND, INCLUDING PERSONAL INJURIES OR DAMAGE TO PROPERTY, EXCEPT AS PROVIDED HEREIN.

This warranty is made by Glideaway and is not made by or on behalf of its distributors, retailers or any other party. Some states or provinces do not allow the exclusion or limitation of incidental or consequential damages or the exclusion of implied warranties or the limitation on how long an implied warranty lasts, so the above limitations or exclusions may not apply to you. This warranty gives you specific legal rights, and you may also have other rights which vary from state to state or province to province. To the extent that the provisions of any applicable legislation expressly replace, eliminate, amend, extend, or prohibit any term or terms contained in this warranty, such term or terms shall be accordingly replaced, eliminated, amended or extended, as the case may be, in accordance with such legislation.



ComfortBase®

Owner's Manual

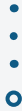

ODESSA

Black Series

SKU: CB18X40R12



8226 LACKLAND RD. ST. LOUIS, MO 63114 | 314.426.3999 | WWW.GLIDEAWAY.COM



REV 11.14.18