

# QUICK START GUIDE: FREESTYLE 2.0

## INCLUDED

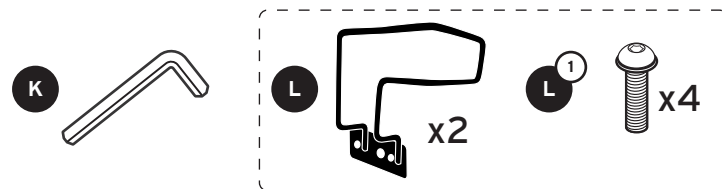

## ASSEMBLY INSTRUCTIONS

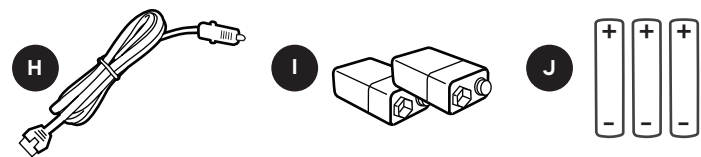
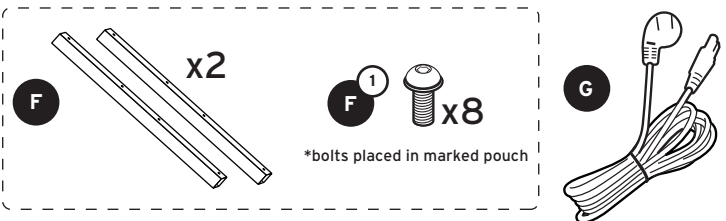
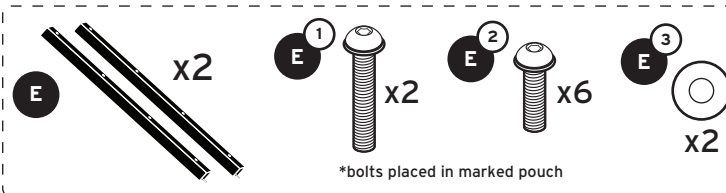
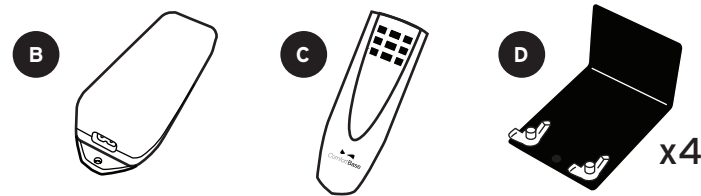
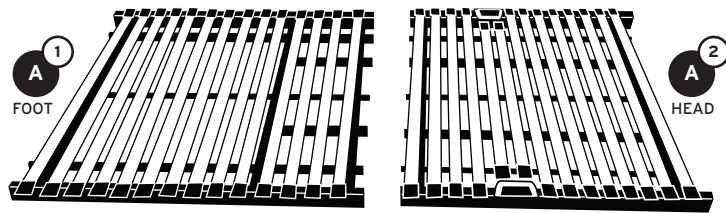
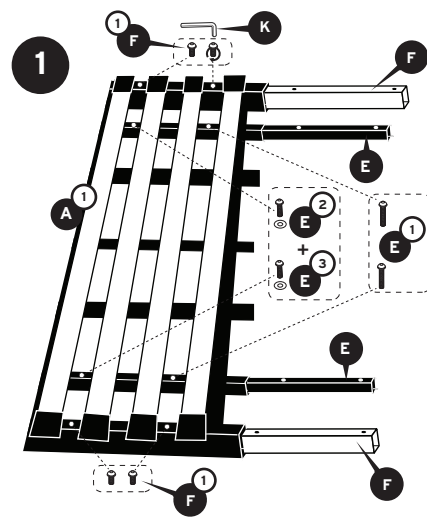

**NOTE:** Interior bars **E** must be oriented HEAD to FOOT as labeled.

**IMPORTANT:** Route cable from foot of bed **A1** to head **A2**, over or under bars as labeled. Improper placement of cable can result in damage to cable.

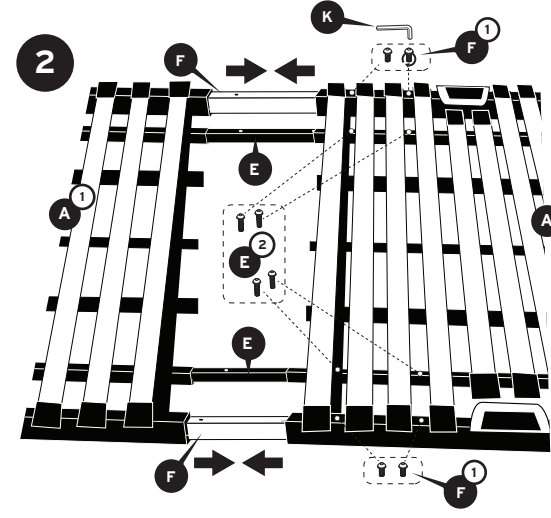

**IMPORTANT:** Slide head and foot of bed together. Tighten exterior bars **F** then interior bars **E**, tightening HEAD section **A2** first then FOOT section **A1**.

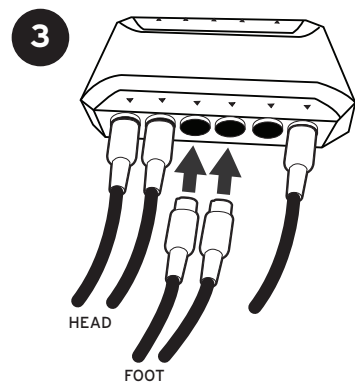

**NOTE:** Lift HEAD of bed to access control box and plug in FOOT motor cables (marked by red bands).

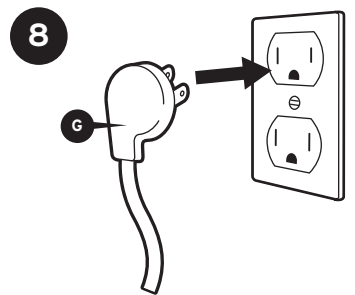
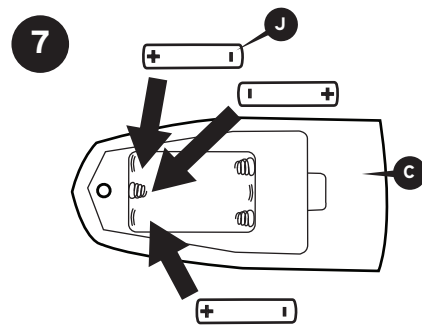
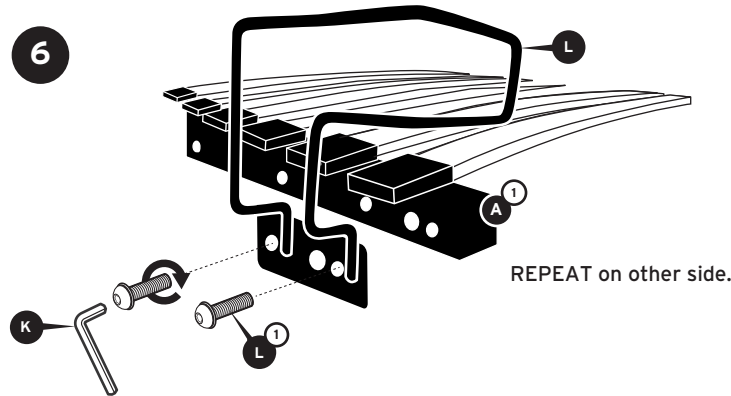
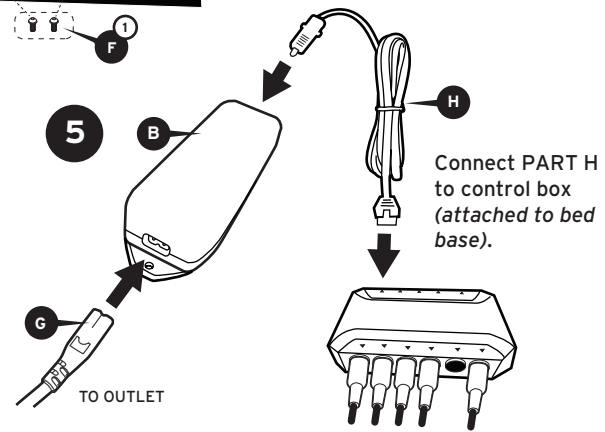
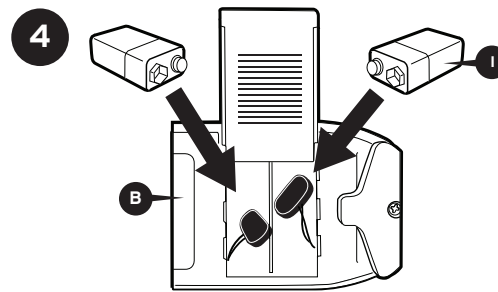

## INSTRUCTIONS TO SYNC REMOTE TO BASE

Bed should already be sync'd. If not, follow these instructions.

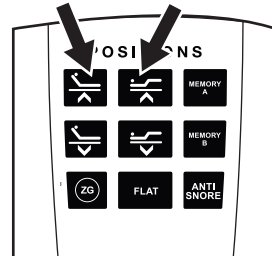
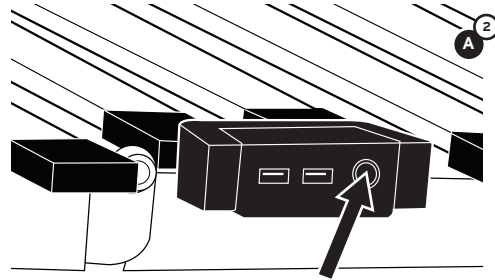

Then simultaneously press and hold HEAD UP and FOOT UP buttons. The remote backlight will flash. When lights turn off, remote should be sync'd. Test to confirm. Repeat if no function.

Press and hold the SYNC button (round button on side of bed) for 5 seconds.

## INSTRUCTIONS FOR MATTRESS BRACKETS

If installing base on FOUNDATION:

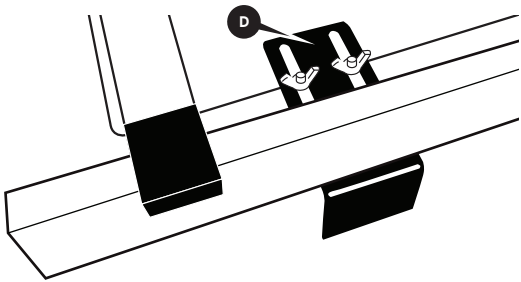

Connect the 4 brackets with wing nuts to the slotted plates in downward position as shown. Tighten wing nuts and make sure brackets are installed flush with the edge of foundation.

If installing base on PLATFORM BED:

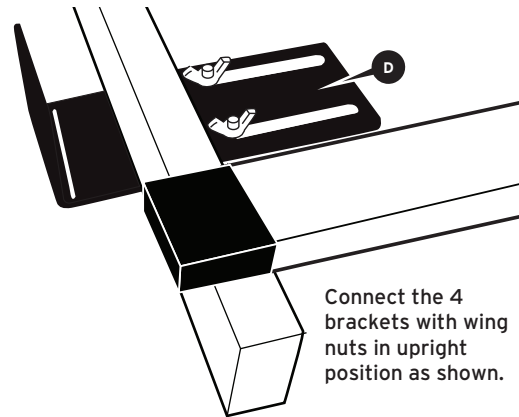

Connect the 4 brackets with wing nuts in upright position as shown.

## EMERGENCY

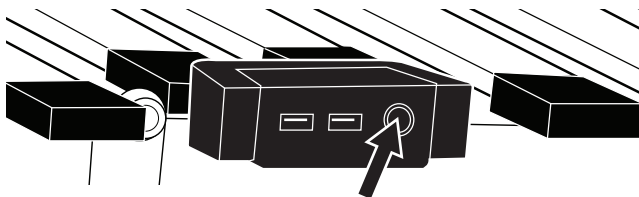

**EMERGENCY STOP:** Press the SYNC button on the side of the base; the LED light around the button will turn red and the bed will stop.

## DOWNLOAD OUR APP

Find us in the Apple or Google Play store. Open the app & follow the instructions. You will then be able to control your Base from any Apple or Android device!



## SAFETY INFORMATION

**ATTENTION!**  
IMPORTANT SAFETY INSTRUCTIONS. SAVE THIS MANUAL! PLEASE READ THESE INSTRUCTIONS THOROUGHLY BEFORE USING THIS PRODUCT. PROPER OPERATION OF YOUR ADJUSTABLE BED IS NECESSARY TO ENSURE THE LONG LIFE AND DURABILITY YOU EXPECT FROM A HIGH QUALITY PRODUCT. THE MANUFACTURER HAS TESTED AND INSPECTED THIS PRODUCT PRIOR TO SHIPMENT.

### RADIO FREQUENCY IS 2.4 GHZ

FCC compliance device complies with part 15 of the FCC Rules. Operation is subject to the following two conditions: (1) This device may not cause harmful interference, and (2) This device must accept any interference received, including interference that may cause undesired operation. Any change to the antenna or the device could result in the device exceeding the RF exposure requirements and void the user's right to operate the device. The input voltage is AC100-240 50/60HZ; the output voltage is DC29V 1.8A.

### ELECTRICAL SAFETY

Always unplug this adjustable bed frame from the electrical outlet before any cleaning or maintenance of the bed frame. To safely disconnect, remove the plug from the outlet. Keep cord away from heated surfaces. Use only indoors. **WARNING: TO PREVENT FIRE OR SHOCK HAZARD, DO NOT EXPOSE THIS UNIT TO MOISTURE.** Discontinue use of this adjustable bed base and contact the manufacturer for repair if: (1) it has a damaged cord or plug, (2) it is not working properly, (3) it has been dropped or damaged. **FOR OPTIMAL SAFETY, YOUR ADJUSTABLE BED SHOULD BE PLUGGED INTO A SURGE PROTECTOR (not supplied with this adjustable bed).**

### BATTERY PRECAUTIONS

Follow these precautions when using batteries in this device:

1. Warning - Danger of explosion if battery is incorrectly replaced. Replace only with the 6LR61 9V batteries and LR03 AAA batteries.
2. Be sure to follow the correct polarity when installing the batteries as indicated in the battery compartment. A reversed battery may cause damage to the device.
3. Do not mix different types of batteries together (e.g. Alkaline, Rechargeable and Carbon-zinc) or old batteries with fresh ones.
4. If the device is not to be used for a long period of time, remove the batteries to prevent damage or injury from possible battery leakage.
5. Do not try to recharge a battery not intended to be recharged; it can overheat and rupture. (Follow battery manufacturer's directions.)

### WARRANTY WARNING

This bed is specifically designed to require no maintenance by you, the user. Any opening or tampering with the control box, motors or hand controls (with the exception of the battery compartment, if equipped) will void the warranty. Do not attempt to alter component wiring or adjust or modify the structure of the product in any way or the warranty will be void. Only those authorized may conduct repairs or part replacement on your adjustable bed.

### IN-HOME USE ONLY

This adjustable bed is designed exclusively for in-home use.

### HOSPITAL/MEDICAL DISCLAIMER

This base is NOT designed for hospital or medical use (In-Home or Commercial) and is NOT designed to meet medical or hospital standards. Do not use this base with TENT TYPE oxygen therapy equipment or use near explosive gases.

### CONSUMERS WITH PACEMAKERS

It is possible that the vibrating feature of this bed may be interpreted falsely by some pacemakers as movement and/or exercise. This is common with any product that produces a vibrating motion, and may or may not affect your pacemaker. Please consult your physician with any concerns.

### PRODUCT RATINGS

Lift Motor Restrictions: The lift motors in this bed are NOT designed to operate continuously for more than one (1) minute over an eight (8) minute time period, or approximately 12% duty cycle. To ensure reliable functionality and full life of this product, do not attempt to exceed these limits. NOTE: Attempting to circumvent or exceed this rating will shorten the life expectancy of the product and may void the warranty.

Weight Restrictions: The recommended weight limits on our adjustable beds are: Queen: 600 lb Full/XL: 500 lb Twin/XL: 400 lb (800 lb if using two twins as a King)

The structure of the bed will support the recommended weight when distributed evenly across the bed. The head and foot sections are not designed to individually support or lift this amount of weight. For optimal performance and integrity of structure, enter and exit ONLY when head and foot sections are flat. NOTE: Exceeding the recommended weight restrictions could damage your adjustable bed and void your warranty.

### SMALL CHILDREN AND PETS WARNING

Immediately dispose of all packing materials as they can pose a smothering risk to small children and pets. Injury could occur also if children or pets are permitted to play on or under the bed. Do not allow children to operate this bed without adult supervision.

### LUBRICATION AND CLEANING

This product is designed to be maintenance free. The lift motors are permanently lubricated and sealed—no additional lubrication is required. Do not apply lubricant to lift motor lead screws or any nylon nuts or the base may inadvertently creep downward from the elevated position.

### LIFT WARNING

DO NOT SIT ON THE HEAD OR FOOT SECTIONS WHILE IN THE RAISED POSITION, OR DURING LIFT OR LOWERING CYCLES.

### LOCATION ENVIRONMENT

The level of sound experienced during operation is directly related to the location environment. It is possible to experience vibration or noise from the headboard brackets, headboards or foot boards if mounting bolts are not firmly tightened.

### MOVING AFTER INSTALLATION

Do not place adjustable bed base vertically on its head, foot sections or sides. This may cause injury to persons or damage to base.

### WARNINGS

To reduce the risk of burns, fire, electric shock, or injury to persons:

- Unplug from outlet before putting on or taking off accessories.
- Close supervision is necessary when this base is used by, or near children, invalids, disabled persons, or pets.
- Use this base only for its intended use as described in these instructions. Do not use attachments not recommended by the manufacturer.
- Never operate this base if it has a damaged cord or plug, is not working properly, has been dropped or damaged, or dropped in water.
- Keep the cord away from heated surfaces.
- Never drop or insert any object into any opening.
- Do not use outdoors.
- Do not operate where aerosol (spray) products are being used or where oxygen is being administered.
- To disconnect, remove plug from outlet.
- DO NOT USE NEAR PEOPLE USING OR WEARING MEDICAL DEVICES. FOR HOUSEHOLD/RESIDENTIAL USE ONLY.

## RESOURCES

CUSTOMER SERVICE  
1 - 855 - 581 - 3095

VISIT US ONLINE  
[www.glideaway.com](http://www.glideaway.com)