



EDISON

OWNERS MANUAL





Contents

| | |
|--------------------------------|----|
| Safety Information | 3 |
| What Is Included | 6 |
| Assembly - Base | 7 |
| Location of Controls - Remote | 12 |
| Operation - Main | 12 |
| Operation - Linking the Remote | 14 |
| Troubleshooting | 15 |
| Available Accessories | 16 |
| Online Resources | 16 |

User Info

Please take a moment and write down the serial number in the space provided below, in case you need to refer to it in the future. This information can be found by raising the head section of the bed.

SKU: GM-030

Serial Number _____

This number will be required for future service claims.

Safety Information

**OPEN BOX IN
FLAT POSITION**

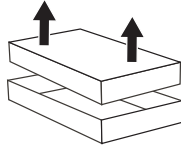

DANGER!
DO NOT OPEN FROM
VERTICAL POSITION. THIS
CAN DAMAGE BASE.

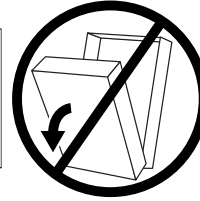

ATTENTION!

IMPORTANT SAFETY INSTRUCTIONS. SAVE THIS MANUAL!

PLEASE READ THESE INSTRUCTIONS THOROUGHLY BEFORE USING THIS PRODUCT. PROPER OPERATION OF YOUR ADJUSTABLE BED IS NECESSARY TO ENSURE THE LONG LIFE AND DURABILITY YOU EXPECT FROM A HIGH-QUALITY PRODUCT. THE MANUFACTURER HAS TESTED AND INSPECTED THIS PRODUCT PRIOR TO SHIPMENT.

RADIO FREQUENCY IS 2.4ghz.

This device complies with part 15 of the FCC Rules and Industry Canada's license exempt RSSs. Operation is subject to the following two conditions:

- (1) This device may not cause interference, and
- (2) This device must accept any interference received, including interference that may cause undesired operation of the device.

Any change to the antenna or the device could result in the device exceeding the RF exposure requirements and void the user's right to operate the device. The input voltage is AC100-240 50/60HZ; the output voltage is DC29V 1.8A. Total USB power output is 2 AMP.

ELECTRICAL SAFETY

Always unplug this adjustable bed from the electrical outlet before any cleaning or maintenance of the adjustable bed. To safely disconnect, remove

WARNING: TO PREVENT FIRE OR SHOCK HAZARD, DO NOT EXPOSE THIS UNIT TO MOISTURE.

the plug from the outlet. Keep cord away from heated surfaces. Use only indoors.

Discontinue use of this adjustable bed and contact the manufacturer for repair if:

- (1) It has a damaged cord or plug,
- (2) It is not working properly, or
- (3) It has been dropped or damaged.

FOR OPTIMAL SAFETY, YOUR ADJUSTABLE BED SHOULD BE PLUGGED INTO A SURGE PROTECTOR (not supplied with this adjustable bed).

BATTERY PRECAUTIONS

Follow these precautions when using batteries in this device:

- (1) Warning – Danger of explosion if battery is incorrectly replaced. Replace only with the 6LR61 9V batteries and LR03 AAA batteries.
- (2) Be sure to follow the correct polarity when installing the batteries as indicated in the battery compartment. A reversed battery may cause damage to the device.
- (3) Do not mix different types of batteries together (e.g. Alkaline, Rechargeable and Carbon-zinc) or old batteries with fresh ones.
- (4) If the device is not to be used for a long period of time, remove the batteries to prevent damage or injury from possible battery leakage.
- (5) Do not try to recharge a battery not intended to be recharged; it can overheat and rupture. (Follow battery manufacturer's directions.)

Safety Information

WARRANTY WARNING!

This bed is specifically designed to require no maintenance by you, the user. Any opening or tampering with the control box, motors or hand controls (with the exception of the battery compartment, if equipped) will void the warranty. Do not attempt to alter component wiring or adjust or modify the structure of the product in any way or the warranty will be void. Only those authorized may conduct repairs or part replacement on your adjustable bed.

IN-HOME USE ONLY

This adjustable bed is designed exclusively for in-home use.

HOSPITAL/MEDICAL DISCLAIMER: This base is NOT designed for commercial hospital or medical use and is NOT designed to meet hospital standards. Do not use this base with TENT TYPE oxygen therapy equipment or use near explosive gases.

PRODUCT RATINGS

Lift Motor Restrictions: The lift motors in this bed are NOT designed to operate continuously for more than one (1) minute over an eight (8) minute time period, or approximately 12% duty cycle. To ensure reliable functionality and full life of this product, do not attempt to exceed these limits.

NOTE: Attempting to circumvent or exceed this rating will shorten the life expectancy of the product and may void the warranty.

Weight Restrictions: The recommended weight limits on our adjustable beds are:

- 1/pc King: 800 lb
- Queen: 600 lb
- Full/XL: 500 lb
- Twin/XL: 400 lb (800 lb if using two twins as a King)
-
- The structure of the bed will support the recommended weight when distributed evenly across the bed.
- **The head and foot sections are not designed to individually support or lift this amount of weight.**
- For optimal performance and integrity of structure, entering and exiting the adjustable bed with the bed in the flat position is recommended.
- **NOTE: Exceeding the recommended weight restrictions could damage your adjustable bed and void your warranty.**

Safety Information

SMALL CHILDREN AND PETS WARNING

Immediately dispose of all packing materials, as they can pose a smothering risk to small children and pets. Injury could also occur if children or pets are permitted to play on or under the bed. Do not allow children to operate this bed without adult supervision.

LUBRICATION AND CLEANING

This product is designed to be maintenance free. The lift motors are permanently lubricated and sealed—no additional lubrication is required. Do not apply lubricant to lift motor lead screws or any nylon nuts or the base may inadvertently creep downward from the elevated position.

LIFT WARNING

DO NOT SIT ON THE HEAD OR FOOT SECTIONS WHILE IN THE RAISED POSITION, OR DURING LIFT OR LOWERING CYCLES.

MOVING AFTER INSTALLATION

Do not place adjustable bed base vertically on its head or foot sections. This may cause injury to persons or damage to base.

WARNING!

To reduce the risk of burns, fire, electric shock, or injury to persons:

- Unplug from outlet before putting on or taking off accessories.
- Close supervision is necessary when this base is used by, or near children, invalids, disabled persons, or pets.
- Use this base only for its intended use as described in these instructions. Do not use attachments not recommended by the manufacturer.
- Never operate this base if it has a damaged cord or plug, is not working properly, has been dropped or damaged, or dropped in water.
- Keep the cord away from heated surfaces.
- Never drop or insert any object into any opening.
- Do not use outdoors.
- Do not operate where aerosol (spray) products are being used or where oxygen is being administered.
- To disconnect, remove plug from outlet.
- DO NOT USE NEAR PEOPLE USING OR WEARING MEDICAL DEVICES. FOR HOUSEHOLD/RESIDENTIAL USE ONLY.

What's Included

Before discarding any packing materials, check the adjustable base shipping carton and verify the following items are included:

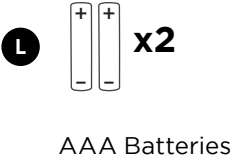
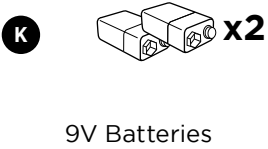
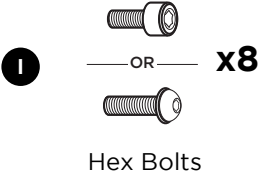
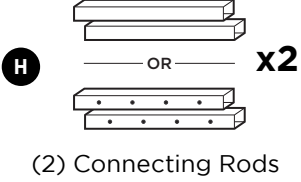
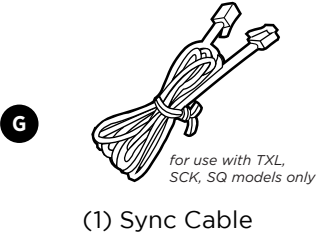
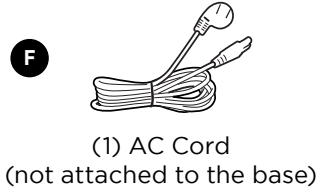
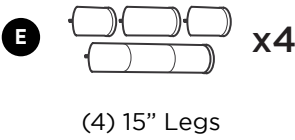
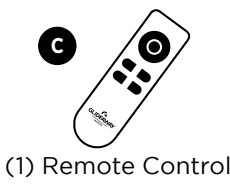
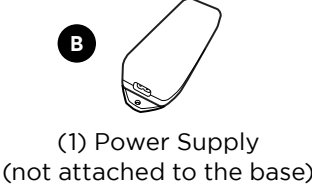
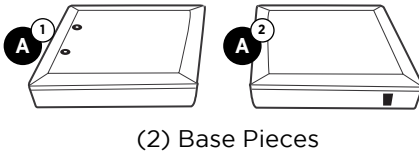

IMPORTANT:
USE 2 PEOPLE TO LIFT BASE TO AVOID DAMAGE.

NOTE:
Carefully lift both Base Pieces from the shipping carton, keeping the unit's top-side down. Remove the plastic wrapping from the bottom to access the bases.

Assembly – Base

It is HIGHLY recommended to use two people for the installation of this product.

To assemble, please perform the following steps:

- 1 Carefully lift both Base Pieces from the shipping carton, keeping the unit’s topside down. Remove the plastic wrapping from the bottom to access the bases.

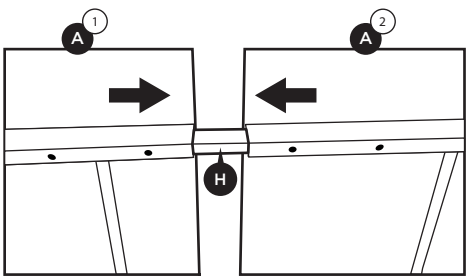

- 2 Insert the Connecting Rods into one of the Base Pieces and then slide the other Base Piece onto the Connecting Rods as shown.

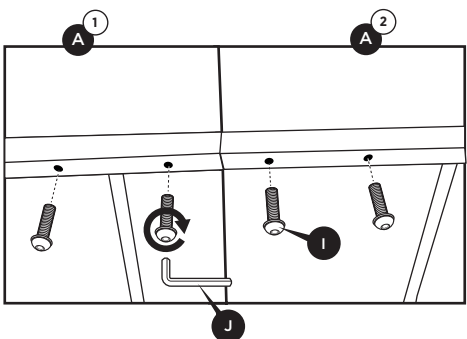

- 3 Secure the Base Pieces to each other using the eight hex bolts (four hex bolts for each Connecting Rod) making sure to hand tighten each and then tighten 1/4 turn more, as over-tightening could cause damage to the frame or Connecting Rod.

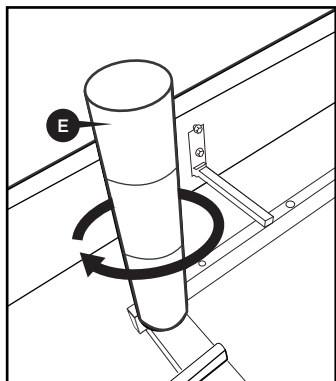

- 4 Insert the legs into the threaded holes at each corner of the base by inserting the leg and rotating clockwise until tight. There must not be any gap or wobble in the leg in order to avoid risk of injury or damage to the base which may void warranty.

NOTE:
 KING SIZE bases require use of at least two leg segments. Failure to use a minimum of two leg segments could result in damage to base and floor and will void your product’s warranty.

Assembly – Base (cont'd)

Please Refer to diagram when assembling the adjustable bed.

FIGURE
A

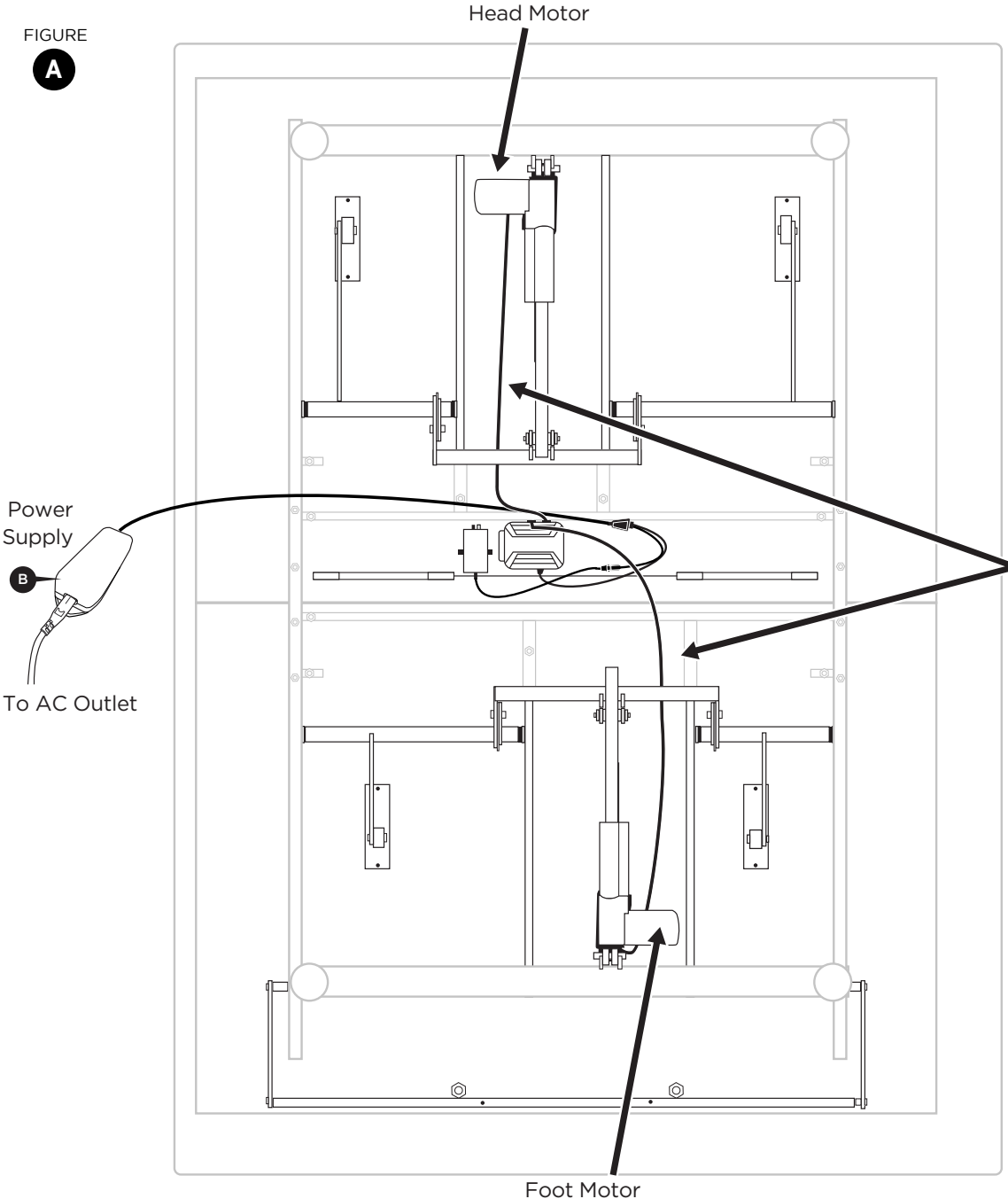

NOTE:
Make sure wire connected to Power Supply is routed UNDER the main metal frame and lifting mechanism. Routing wires on top of the metal frame are likely to result in damage to the base which may void the warranty.

Assembly – Base (cont'd)

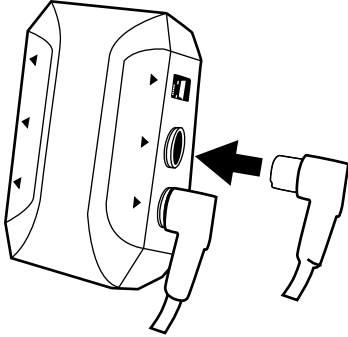

5 Connect the Foot motor connector cable to control box.

REFER TO FIGURE A ON PAGE 8.

NOTE:
The Head and Foot motors are labeled per illustration.

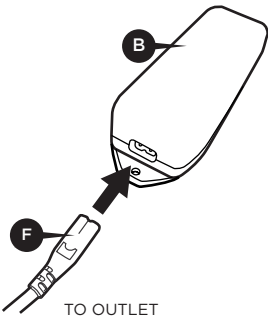

6 Insert the AC cord into the power supply.

IMPORTANT:
DO NOT PLUG THE BASE INTO THE AC OUTLET YET.

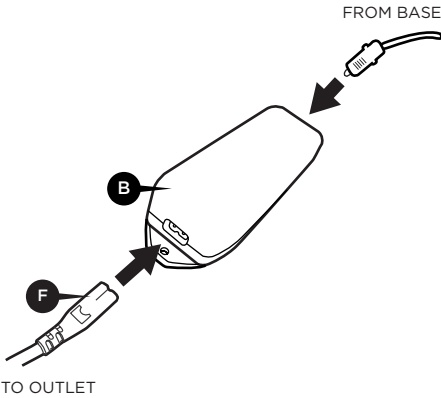

7 Insert DC cord from base into the power supply.

8 Finish removing the plastic packaging from the base to orient into final position. Remove the Mattress Retainer Bar from the bottom of the base. Carefully rotate the base on its side, then lift and place on legs.

IMPORTANT:
DO NOT LEAN THE BED AGAINST THE INSTALLED LEGS TO TURN OVER.

Assembly – Base (cont'd)

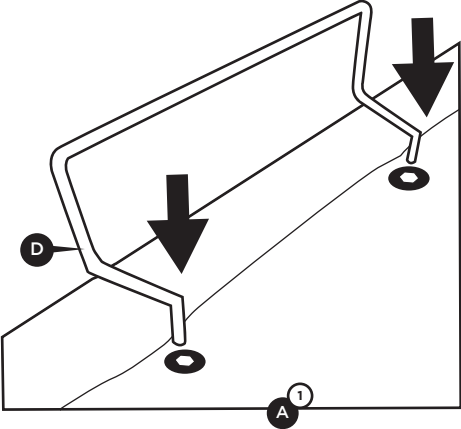

9 Insert the Mattress Retainer Bar upright as shown.

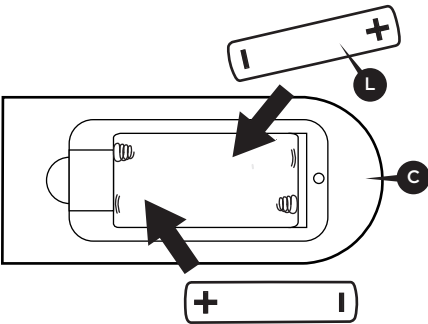

10 Lift the battery cover and insert the two AAA size batteries (included) into the remote as shown in the figure. Replace the battery cover. Remote is already linked with the base.

TO LINK REMOTE:
If the remote is not linked, see page 14.

When setting up a Split Cal King or two Twin XL beds to form a King, refer to the instructions on page 14 on how to link your remote.

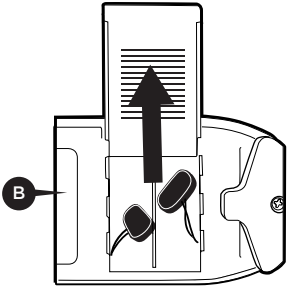

11 Turn the power supply upside down to access the battery cover, then slide the battery cover off.

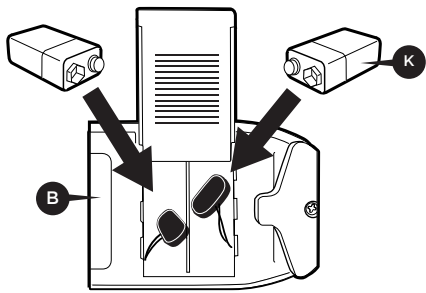

12 Insert the two 9V batteries (included) into the compartment and slide the cover back on.

NOTE:
The battery backup will allow for the bed to be lowered if a power outage occurs. It is not recommended to do anything except lower the bed, as the battery backup will not last if the features are continually used.

Assembly – Base (cont'd)

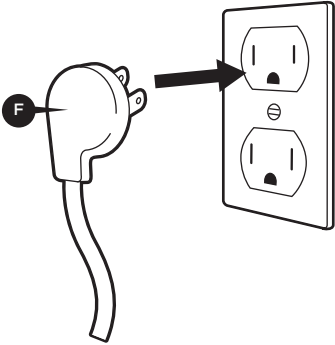

13 Insert AC plug into an AC outlet having 100-240V AC, 50/60Hz. Avoid outlets that work only with light switch.

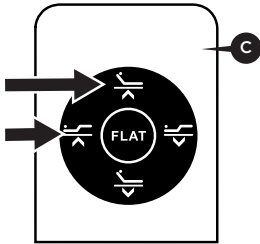

14 Initial use of base requires additional run time. Simply press the Head Up button on the remote until the head section begins to lift. Then press the Foot Up button on the remote until the foot section begins to lift.

NOTE:
If attaching headboard brackets (available separately) to the base, see the included instructions. Otherwise, place the desired mattress onto the base and enjoy your new adjustable base!

Location of Controls – Remote

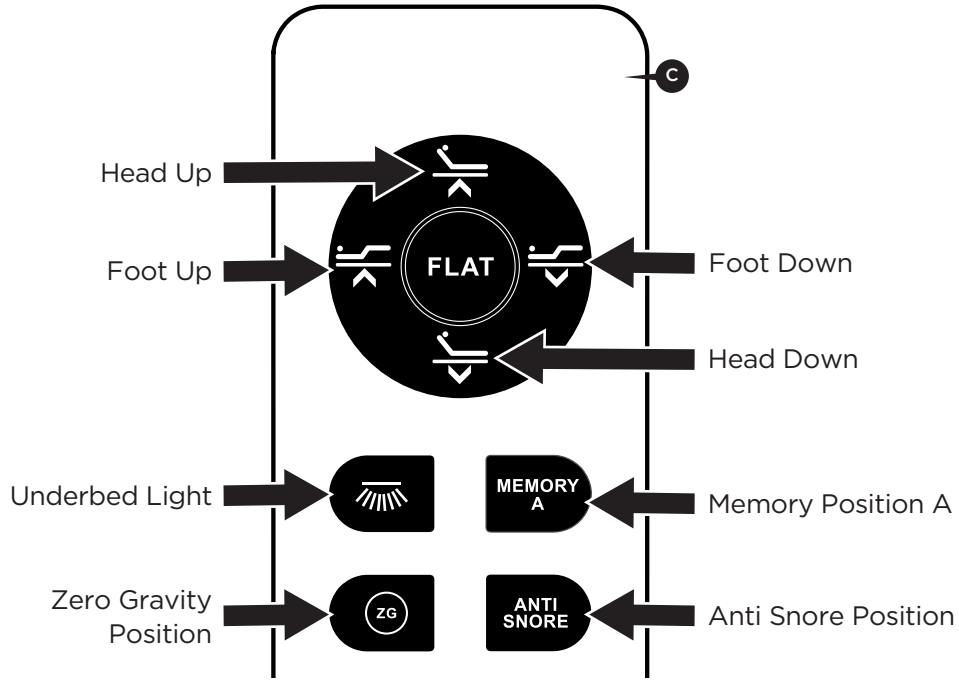

Operation – Main

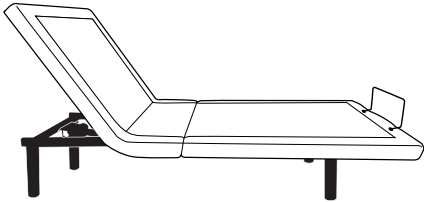

 Press and hold the Head Up button to raise the Head position. Release button when desired position is reached.

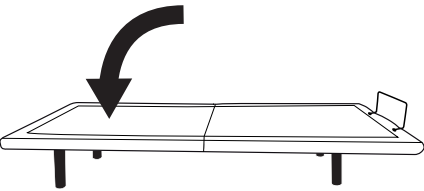

 Press and hold the Head Down button to lower the Head position. Release button when desired position is reached.

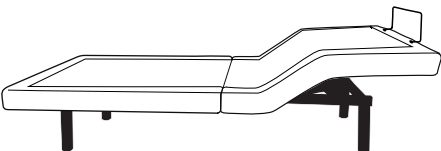

 Press and hold the Foot Up button to raise the Foot position. Release button when desired position is reached.

Operation — Main (cont'd)

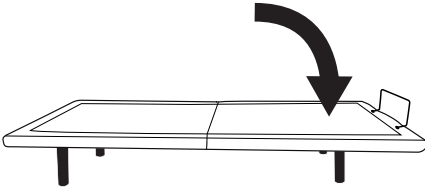

Press and hold the Foot Down button to lower the Foot position. Release button when desired position is reached.

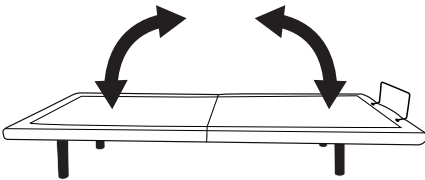

Adjust head and/or foot section(s) to desired positions. Press and hold Memory A button until the backlight on remote flashes. Release button and wait for flash to stop. Button has now been programmed. Repeat process if new pre-set position is desired.

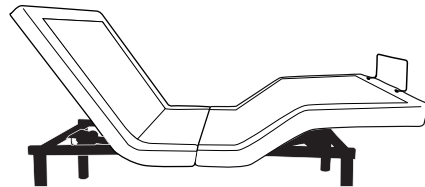

Press the Zero Gravity button and the head and foot positions will go to the Zero Gravity position. This action can be stopped at any time by pressing another button.

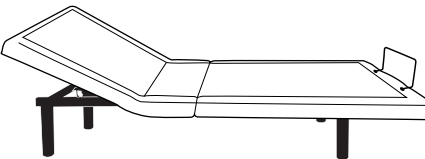

Press the ANTI-SNORE button and the Head position will go to the Anti-Snore position. This action can be stopped at any time by pressing another button.

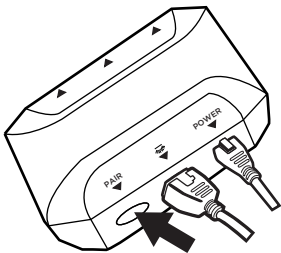

NOTE:
EMERGENCY LOWERING: If you cannot find the remote control, locate, press and hold the pair button located on the main control box on the bottom of the bed (shown to the left).

Operation - Linking the Remote

Connecting 1 Remote to 1 Base

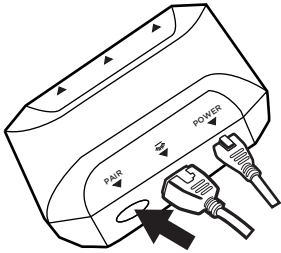

1 Double click the PAIR button on the control box (light will turn blue).

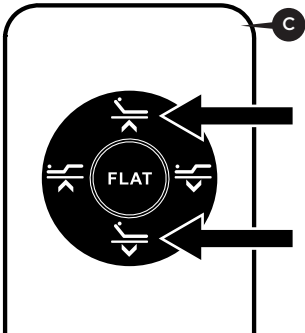

2 Simultaneously press & hold the HEAD UP and HEAD DOWN buttons. When the LED light on the control box turns green, release the two buttons.

3 Test the bed to make sure it is working. Repeat the steps if it is not.

Connecting 1 Remote to 2 Bases

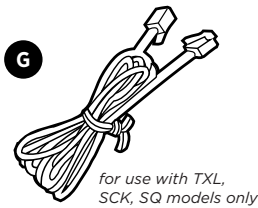

Sync Cable

1 Connect each base to the other using the sync cable (insert into slot labeled SYNC on each control box). Route sync cable under frames when installing. Both beds should be in Flat position when installing sync cables to avoid improper cable routing

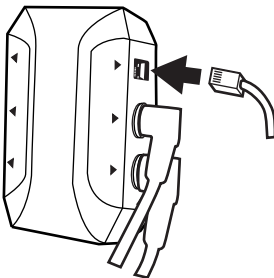

Troubleshooting

In the event the base fails to operate, investigate the symptoms and possible solutions provided below:

Remote control illuminates and appears to be operable, but no features of the base will activate.

- Unplug power cord, wait 30 seconds and plug in to reset electronic components.
- Defective surge protection device or electrical outlet. Test outlet by plugging in another working appliance.
- Electrical circuit breaker may be tripped. Check electrical service breaker box to verify.
- Re-link the remote control (see Remote Control Re-Linking section of this manual for programming procedures).
- Replace batteries in the remote control & relink remote control.

No features of the base will activate.

- Unplug power cord, wait 30 seconds and plug in to reset electronic components.
- Defective surge protection device or electrical outlet. Test outlet by plugging in another working appliance.
- Electrical circuit breaker may be tripped. Check electrical circuit breaker box to verify.

Remote control will not illuminate.

- Replace batteries in the remote control.

Head section will elevate, but will not return to the horizontal (flat) position.

- Base mechanism may be obstructed. Elevate base and check for obstruction. Remove obstruction.
- Headboard may be too close to the edge of the mattress. Verify that distance between headboard brackets and mattress is sufficient. Adjust if required.

Head or Foot Lift Function has minor interference during operation.

- Check batteries in remote, replace if necessary.
 - Make sure that you are following the duty cycle of the motor (do not operate more than one (1) minute over an eight (8) minute period, or approximately a 12% duty cycle).
 - Press the lift buttons squarely and accurately.
 - Control box may be experiencing common Radio Frequency Interference from other radio transmitting devices (see Remote Control Re-Linking section).
-

Available Accessories

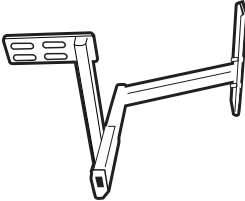
| | Item | Part Number |
|---|--|-------------|
|  x4 | High Profile Legs (Overall Bed Height 18.5") | CB12LEG18.5 |
|  | Headboard Bracket Kit | CB18HBBRKT |

To order an accessory, please call 1-855-581-3095

Resources

CUSTOMER SERVICE
1-855-581-3095

VISIT US ONLINE
glideaway.com

EDISON

Sleep Well. Live Better. Be Your Best.

